



Aurora Cantilever

Owner's Manual

Congratulations on purchasing your Aurora Cantilever Umbrella. The Aurora is manufactured using the highest grade materials and fabrics on the market, and is perfectly designed to give you many years of enjoyment. The following information will explain how to operate your Aurora Cantilever Umbrella to ensure trouble free use and ease of operation. Please follow these instructions as they are designed to assist operation and prolong the life of your umbrella.

SIMPLE MAINTENANCE PROCEDURES

Your Aurora Cantilever Umbrella is virtually maintenance free. The tips below should aid in the overall longevity of the product and keep the umbrella working optimally for years to come.

- In coastal or metropolitan environments, frequent washing of the complete unit is beneficial. Particularly the slider car (**21**), Slider Car guide tracks, and rotating assembly (**27**).
- If you are in a coastal environment, simply spray with fresh water to remove any salt water and salt air deposits on the aluminum. This helps prevent calcium buildup and reduce the need for more intensive cleanings.
- If extensive calcium buildup or hard water stains are an issue, this can be remedied with 2tbsp of white vinegar per every quart of boiled fresh water and a soft nylon bristle brush. **Do not use steel or stainless steel bristles.**
- Should the rotating position holes on the Spigot (**30**) become filled with debris, lifting your umbrella up off the Spigot (**30**) by 1” will allow the Indexing Bushing (**31**) to be lifted and the 16 holes can be cleaned. This will be a two person operation.
- Spraying silicon to the Mast (**13**), Slider Car (**21**) and visible pulley wheels will assist operation if required and is a good idea before storing away for a season.
- Fold the acrylic canvas as mentioned in “Closing The Aurora” (Page 12). This will prolong the new look of the fabric and prevent marking caused by “pinching” in the alloy frame.
- All parts are virtually maintenance free (e.g. aluminum, stainless steel, etc.) However, the above mentioned care is recommended to increase the overall longevity of the umbrella.
- If the umbrella is not to be used for an extended period of time (winter months), you may remove the umbrella from the Spigot (**30**), place in storage and then remove the Spigot (**30**) as it can be a tripping hazard.
- The included protective cover should be used when the umbrella will not be operated for an extended period of time.

Aurora Cantilever umbrellas are engineered to withstand moderate sustained winds at an optimal 90° angle. The addition of the wind stabilizer kit increases this tolerance by 5mph.

Do not attempt to open or utilize the tilt feature at any degree of tilt in windy conditions.

Frankford umbrellas have been tested successfully in extreme weather and winds, however, we strongly recommend closing your umbrella when not in use, or in moderate sustained winds.

WIND RATING

Wind ratings do NOT form part of, nor fall under, any Frankford Umbrellas' warranties. Wind ratings are intended as a guide to the relative strength of the umbrellas only and tested at their optimal 90° and non-tilted positions. Wind can be extremely variable, depending on the surroundings, elevation, angle of gusts, etc. In any high wind or sudden extreme weather conditions, all umbrellas should be closed and secured immediately.

Frankford can recommend specific bases and anchoring systems for specific umbrella types. However, these are only recommended weights, as different environments may require different base options. Please contact us for assistance in choosing the proper umbrella base or anchoring system.

In the event Frankford shade products are left open and/or unattended in harsh weather conditions, our customer service department is here to help you and promptly assist with parts for repairs. Our shade products offer modular, self-repairable components which allow customers to service the umbrellas to keep them in perfect working condition.

COMMERICAL WARRANTY



RESIDENTIAL WARRANTY



GALVANIZED STEEL MAINTENANCE



GENERAL INFORMATION

Your Aurora Cantilever Umbrella is principally intended for use in low to moderate wind conditions and will provide you with many hours of protection from sun and light rain. You will get maximum benefit from your umbrella when you use it in accordance with our instructions and in the weather condition for which it was designed.

- Do not attempt to open the umbrella in windy conditions. This may cause unwanted stress on the cranking system as the large umbrella canopy needs to work against the winds.
- Before you begin to open your umbrella, be sure to loosen the Slider Car Knob (23a) so that the Slider Car (21) can travel freely and float along the mast (13) while cranking. Tighten the Slider Car Knob (23a) into position only when the canopy is fully open.
- When you first open your umbrella, the fabric will be stiff and you will notice a 1-3" gap between the Hub Tube (9) and Tube Locator (8). This is normal and as the fabric relaxes this connection will seat perfectly when fully open.
- **DO NOT PUSH THE SLIDER CAR UP INTO ANY DESIRED POSITION BEFORE THE UMBRELLA CANOPY IS FULLY OPEN. THIS IS TO MAINTAIN TENSION ON THE CABLE SYSTEM TO AVOID ANY KINKING OR TANGLING, RENDERING THE UMBRELLA INOPERABLE.**
- "Fluffing The Ribs" - When the umbrella is fully closed, the ribs will pass a 180° angle hindering them from opening from simply cranking. Give the ribs a slight pull out from the bottom hub (6) ("fluff") while cranking.
- Do not leave umbrella open when unattended, particularly in windy conditions. Your Aurora Umbrella should be closed and securely strapped in strong winds and adverse weather conditions.
- When using the Wind Stabilizer bars (24), your Aurora should be at it's 90° locked angle, and Slider Car Knob (23a) tightened. **The Wind Stabilizer bars are not to be used when the umbrella is in any degree of tilt or closed.**
- Always secure your umbrella to a Frankford base that is appropriate to the environment in which it is going to be used.
- Be careful when closing to ensure the canopy does not get caught or "pinched" by the umbrella arms.
 - After the umbrella is closed, remove the inward fold by pulling fabric panels "out" from the center
 - Once all fabric panels are pulled, fold one over the other towards the front face of the canopy
 - Firmly wrap the supplied Velcro fabric strap and place the protective cover over your umbrella

This is particularly important before storing the umbrella away for extended periods of time or if the umbrella is to be laid horizontally for storage. Damage to the fabric caused by "pinching" is not covered by the warranty. Follow all manufacturer's assembly instructions.

- Make sure your Aurora is dry and clean prior to storing away for extended periods of time to prevent mold from developing on dirt and directly onto the fabric.
- Inspect the installation fitting/base on a regular basis and tighten as necessary.
- Please avoid any modifications to your umbrella, except those made by an authorized Frankford customer service agent. Unauthorized modifications will void the warranty.

FABRIC CARE

Recacril® 9 oz. marine-grade acrylic fabric is treated with the Infinity Process, a highly technological finish providing Recacril® with long-lasting protection against mold and mildew, excellent water and oil repellency, and protection from the sun. However, the accumulation of dust, pollution particles, foreign organic materials, and general dirt can damage this protection, shortening the life of the Recacril®.

The most effective method for maintaining Recacril® is to clean the canvas once a month with water, using a low-pressure hose. It is very important that after cleaning with water, the canvas be allowed to completely dry before rolling or storing your umbrella. If for any reason you must roll and/or store a wet umbrella, it must be unrolled and opened as soon as possible to dry. In times of continuous rain, it is advisable to keep the umbrella rolled and stored.

If periodic washing with water is done, in most environments, you should only need to do a more thorough cleaning every 2-3 years.

FABRIC LONGEVITY

When the umbrella is closed, you'll notice the weight of the fabric from the panels will tuck and fold in towards the center hub and becoming pinched between the ribs of the frame. Leaving the fabric in this state will cause premature wear and tear. Simple friction of constant rubbing and pinching can cause micro tears and pinholes on the fabric. This is not detrimental to the integrity of fabric's overall state, however continued neglect over time will cause the tears and pinholes to increase in size and cause a premature replacement of the canopy.

To prevent this, after closing the umbrella, pull the panel fabric out and fold each panel in an over/over method before wrapping with the supplied Velcro fabric tie.

CASUAL CARE & CLEANING

- Brush off dust and dirt with a soft brush. NEVER brush with stiff brushes since this can damage the fabric finish.
- Spray the umbrella with clean water. If a hose is used, avoid high pressure.
- Prepare a solution of solvent-free soap in warm water (no more than 100°F) and apply it to the fabric and stitching.
- Scrub with a soft brush, allowing the solution to penetrate the fabric.
- Rinse with water to remove all traces of soap.
- Let air dry and do not close the umbrella until canvas is completely dry.

INTENSIVE CARE & CLEANING

- Brush off dust and dirt with a soft brush. NEVER brush with stiff brushes as this can damage the fabric finish.
- Prepare a solution with 10% household bleach, 20% solvent-free neutral detergent (free & clear detergents), and 70% water.
- Apply the solution to the fabric, allowing it to remain between 15 and 20 minutes maximum.
- Rinse with clean water several times. Any bleach residues remaining on the canvas, combined with the sun, could damage the fabric and stitching.
- Let air dry and do not close the umbrella until canvas is completely dry.
- Repeat the process if necessary.

1. Rib/Stretcher Assembly
2. Rib End Fitting
3. SS Canopy Screws
4. TPU Vertex Finial
5. Top Hub
6. Bottom Hub
7. Bottom Hub Cover Cap
8. Hub-Tube Locator
9. Hub-Tube
10. 4mm Stainless Steel Cable
11. Spool Winder Rope
12. Internal Spool
13. Mast
14. Mast Cap
15. Main Arm
16. Main Arm Hardware
17. Mast Arm
18. Mast Arm Hardware
19. Mast Strop
20. Bottom Stay
21. Slider Car
22. Finial Receiving Hub
23. Infinity Tilt Assembly
24. Wind Stabilizer Kit
25. Wind Stabilizer Block
26. Crank Handle
27. Rotation Assembly
28. Rotation Handle
29. Rotation Locking Block
30. Internal Spigot
31. Indexing Bushing
32. Black Polyester Protective Cover

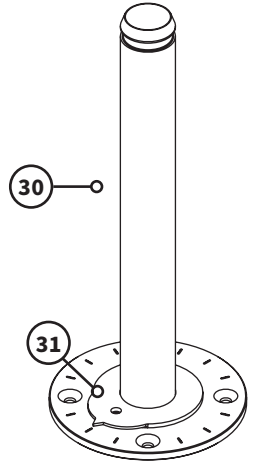
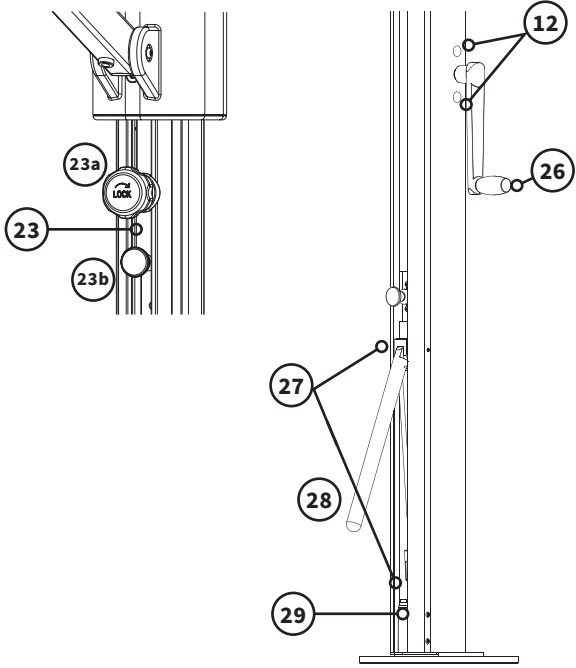

898ARU-R / 883ARU-SQ SPECIFIC

- 1a. Long 45° Rib
- 2a. Mid 22.5° Rib
- 3a. Short 180° Rib (882ARU-R) (882ARU-F-R)

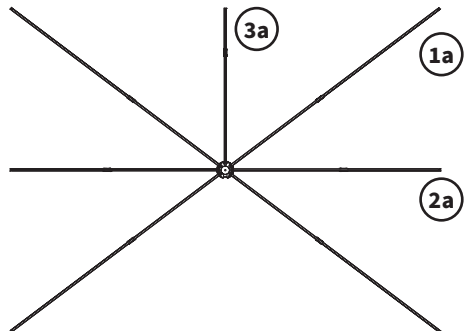
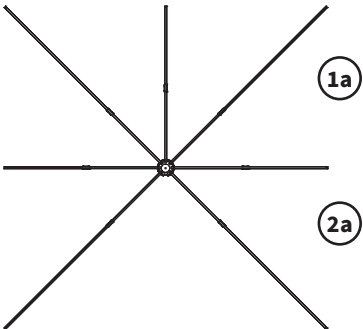

Aurora Aluminum /Aurora Fiberglass PARTS KEY

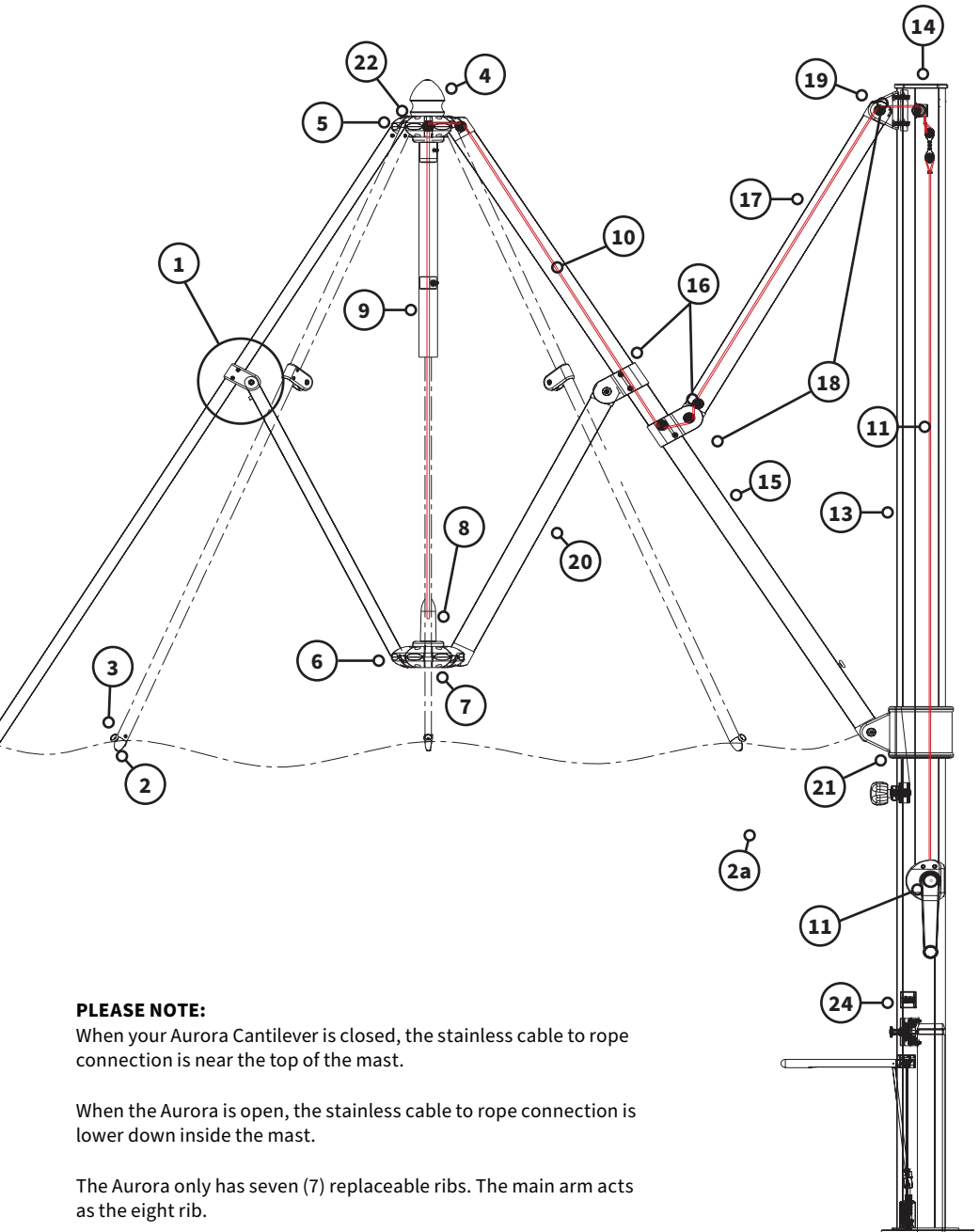

PLEASE NOTE:

When your Aurora Cantilever is closed, the stainless cable to rope connection is near the top of the mast.

When the Aurora is open, the stainless cable to rope connection is lower down inside the mast.

The Aurora only has seven (7) replaceable ribs. The main arm acts as the eight rib.

ROTATING AND LOCKING

Your Aurora Cantilever Umbrella is delivered fully assembled. There are four different ways to install your Aurora Cantilever Umbrella:

1. Installing on a wooden deck using a Deck Plate.
2. Installing on an existing concrete slab or pavers using a Deck Plate.
3. Installing into the ground (i.e. into a lawn, garden or paved patio) using the In-Ground mount.
4. Installing on a free-standing base.

Prior to installing your installation mounts please read the important information below.

ALIGNMENT

Your Aurora Cantilever Umbrella can rotate 360° and be locked in 16 different locations. This means that every 22.5° of rotation there is provision to lock the umbrella. In most situations there will be a preferred area over which you will predominantly want shade. To ensure you have the ability to shade your preferred location you must have one of the 22.5° rotation locking holes (**Figure A**) in line with this position. Please have a look at the underside of your Spigot (**30**) to see these 16 locking holes. Four of the locking rotation points are the Spigot bolt holes in the Spigot plate.

To point your umbrella in the perfect direction or to have a symmetrical installation (especially when installing square umbrellas) it is very important to make sure you install the Base Plate or In-Ground mount square to the direction that you predominantly want the umbrella to point.

Your Aurora Cantilever come with the Spigot (**30**) already inserted in the mast of your umbrella. It is an integral part to the installation and mounting of your umbrella.

The Spigot (**30**) is secured within the mast of the Aurora by the Spigot locking bolt (**30**). Use the hardware provided to lock and unlock your mast from the Spigot (**30**).

1. You can mount the Spigot (**30**) to your choice of installation first, and then secure your Aurora by lifting over and onto the Spigot (**30**) then use the hardware provided to lock your mast to the Spigot (**30**).
2. You can leave the Spigot (**30**) inside of your Aurora and mount the umbrella and Spigot (**30**) together as a whole to your choice of installation.

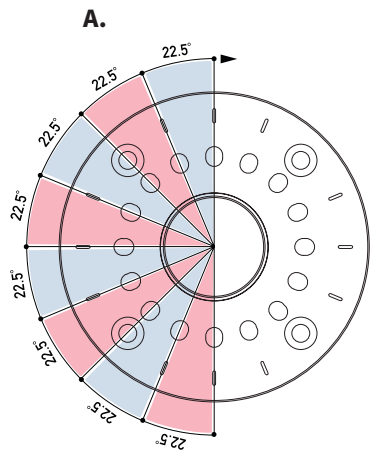

GUIDELINES TO CONSIDER BEFORE INSTALLING

ROTATIONAL SPACE

Be aware of the clearance space required if you wish to rotate your umbrella. Nearby walls, trees, fences or a building can limit this umbrella feature. Positioning your umbrella in a corner can severely limit your space to rotate.

CHECK THE SPACE

Where possible, we recommend the umbrella is stood up in the desired installation location, and fully opened before installing the ground anchors. This is to ensure that the umbrella will fit and that the installation location is correct. We recommend this is done in little or no wind.

OPENING ARC

When choosing a location to install your umbrella, it is important to be aware of the umbrella's arm closing height and opening arc. Your umbrella may connect with a wall, fence or furniture if situated too close.

A good rule of thumb when installing an umbrella with full 360° ROTATION, measure for canopy depth fully and rotate for clearance.

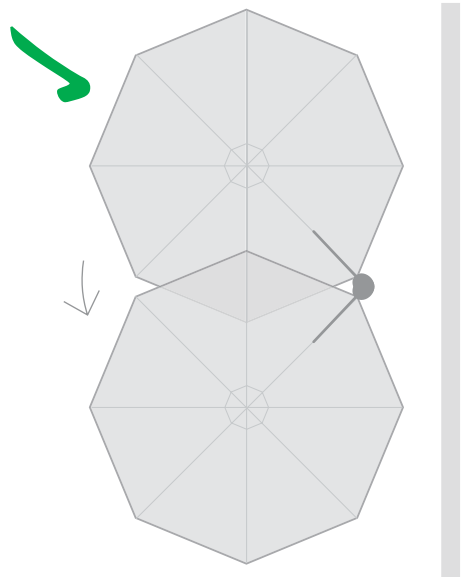
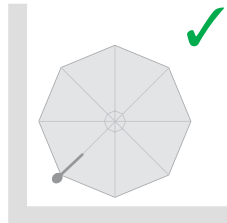
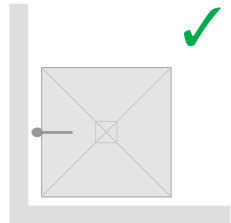
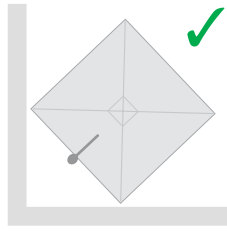
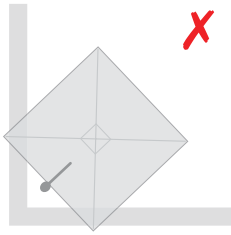
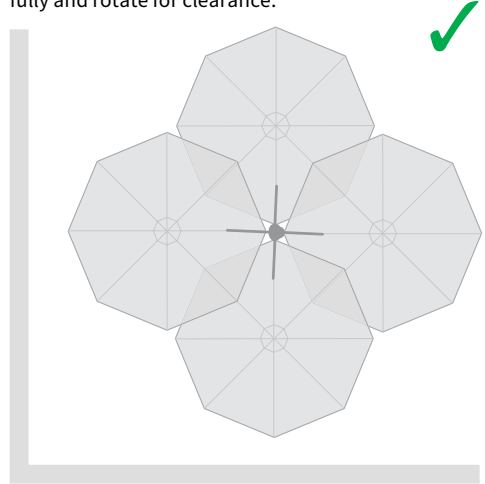

**BEFORE INSTALLING, REMOVE ALL GRUB SCREWS FROM
YOUR BASE, SURFACE AND IN-GROUND MOUNT**



**GRUB-SCREWS ARE IN PLACE TO PROTECT THE THREADED HOLES ON
BASES DURING SHIPPING AND STORAGE. THEY MUST BE REMOVED AND
DISCARDED BEFORE THE INSTALLATION OF ANY UMBRELLA.**

MOUNTING HARDWARE FOR BASES, IN-GROUND & SURFACE MOUNTS

**PLEASE BE AWARE OF HARDWARE NEEDED FOR SPECIFIC BASES. NOT
ALL HARDWARE WILL WORK WITH ALL BASE CONFIGURATIONS AND OR
MOUNTS.**

You may receive additional mounting hardware with your umbrella that is not needed for specific mounting selection. Please see the specific mounting installation pages (15-26) in this manual for your specific hardware needed, and detailed mounting instructions.

ENCLOSED MOUNTING HARDWARE

Scan the **QR- CODE** for the video tutorial on how to properly and efficiently stack the galvanized plates using frankford guide pins.

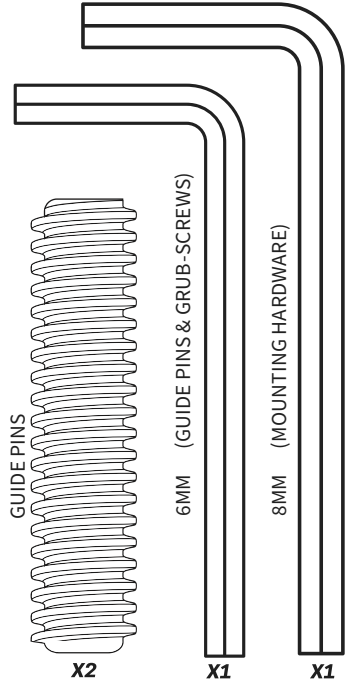
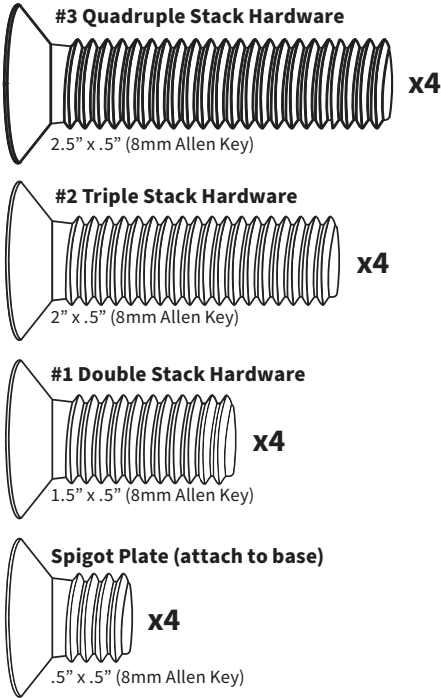

MOUNTING INSTRUCTIONS GUIDES



IN-GROUND
INSTALLATION



WOOD DECK SURFACE
INSTALLATION



CONCRETE PAD SURFACE
INSTALLATION



GALVANIZED
PLATE STACKS

OPENING THE AURORA

- 1 Remove the strap from the canopy.
- 2 Gently spread the canopy arms open (**Figure A**).
- 3 Ensure the Slider-Car Tilt Locking Knob (**23a**) is loose and slider-car (**21**) can move freely (**Figure B**). Insert the Crank Handle (**26**) into the hole on the side of the mast and rotate in a clockwise direction.



Figure A - Gently spread the canopy arms open

- 4 Continue winding until the canopy is fully open and the edge of the canopy is firm (**Figure C**).
Note: The winder handle will become a little harder to wind as the umbrella nears fully open. Stop winding when the canopy is taut/firm. Do not overwind.



Figure B - Ensure tilt locking knob is loose (turn counter clockwise) when opening and closing umbrella

- 5 Once the canopy is fully opened, hold the Tilt Locking Knob (**23a**) and push the slider-car (**21**) up until the canopy is at the desired tilt angle. Tighten Tilt Locking Knob (**23a**) clockwise to secure the umbrella at that angle.

IMPORTANT: The Tilt Locking Knob (**23a**) must be done up tightly, especially when used in exposed locations. The umbrella should not be tilted when windy.

- 6 When the slider-car is pushed up to the highest point, the Locking Pin (**23b**) will automatically engage, locking the canopy in the horizontal position. The optimum strength of the umbrella is reached only when the canopy is in the horizontal position, with the slider-car (**21**) at its maximum height and the Locking Pin (**23b**) engaged.

- 7 The tilt angle of the canopy can be adjusted as required at any time by loosening the Tilt Locking Knob (**23a**), pulling the locking pin (**23b**) outward and sliding the slider-car (**21**) up and down the mast.

Note: The locking pin (**23b**) will only engage at the horizontal level.



Figure C - Edge of canopy should be tight

CLOSING THE AURORA

- 1 **Figure A** - Turn the Tilt Locking Knob (23a) counter-clockwise until loose, hold the tilt locking knob and pull the slider car (21) down the mast towards the ground. If the canopy is in the horizontal position, pull the locking pin (23b) out first.
- 2 Rotate the Crank Handle (27) in a counter-clockwise direction. The canopy will begin to collapse. It is important to draw the loose canopy folds out from between the arms whenever closing it to avoid the canopy getting pinched between the arms. Continue winding in a counter-clockwise direction until the canopy is mostly closed and the canopy arms are pointing almost vertically to the ground'.
- 3 **Figure B** - Fold the canopy neatly when storing for extended periods of time to reduce the risk of damage to the canopy caused by constant rubbing against the umbrella frame. To do this, stand in front of the canopy and take hold of the front two panels, pull them away from the umbrella towards your body and roll them together back towards the umbrella frame. Hold the rolled panels with one hand, while grabbing a third panel, tightly folding it over the roll to hold it in place, alternate folding over the remaining five panels from left to right.
- 4 Secure the folded panels in place with the canopy strap, wrapping it firmly around the mast and canopy. Gently push the folded canopy back against the mast so that it is compact. **IMPORTANT:** When the umbrella is closed it should always be firmly strapped.
- 5 **FITTING THE PROTECTIVE COVER:** Stand beside the folded canopy and open the coverbag zip completely. Use the handle rod to lift the coverbag behind the mast and up as high as possible to clear the top of the umbrella. Pull the coverbag down over the top of the mast and canopy. Zip the coverbag closed. The zip should be on the front side of the canopy, not at the back of the mast.



Figure A - Ensure tilt locking knob is loose (turn counter-clockwise) when closing umbrella



Figure B - Closing down and applying the protective cover.

ROTATING THE AURORA

There are multiple rotational-locking holes in the spigot (30). These location holes are indicated on the top of the spigot base and are under the nylon indexing shield (34) which acts as a dust cover for the holes not in use.

- 1 Lift the Rotation Handle (28) out from the mast cavity (Figure A).
- 2 Lift up on the handle and feel the resistance from the spring that houses the rotating lock pin (29).

WARNING: In lifting this handle you are not attempting to lift the whole umbrella, rather just the spring on the rotating lock pin that locates the rotation lock pin.

- 3 By using the rotating-lift handle (28) as a lever, you can rotate the umbrella on the base until you arrive at the new desired position.
- 4 Each position is marked by a notch on the spigot plate. Align the indicator arrow with a notch (refer Figure B). Once aligned with a notch, lower the rotating handle to engage the rotating-lock pin.

WARNING: Do not force the rotating handle down if the indicator arrow is between notch positions. The rotating handle should close easily. If any resistance is encountered do not force it, rotate the umbrella further until the pin engages in a locking hole.



Figure A - Lift rotation handle. Lift further to disengage locking pin



Figure B - Align the indicator arrow with a notch

INSTALLING WIND STABILIZER KIT

NOTE: The Wind Stabilizer Kit can **ONLY** be used while the umbrella is at its optimal 90° position indicated by the locking pin, and the knob is tightened. This kit cannot be used while the umbrella is at **ANY DEGREE OF TILT**.

1. While the umbrella is open (**Figure B**), slide the stay block (**24**) to the height of the stabilizer bars. Begin to thread into the stay block using the thumb-screw.
2. Attach the threaded stainless screw (with the two aluminum bars attached) to the stay block in the mast and tighten the screw sufficiently for the stay block to remain in position without sliding down the mast (**Figure B**).
3. Swing either aluminum-stay arm off the ground and attach to the umbrella arms using the Star Thumb-Screw fittings. (**Figure C**).
4. You may need to loosen the locking knob (**Figure B**) and adjust up or down the mast for the stabilizer arms to reach the correct position on the arms (**Figure C**). Once both stabilizer arms have been attached, tighten the central threaded-locking knob to lock in position.



FIGURE A



FIGURE B

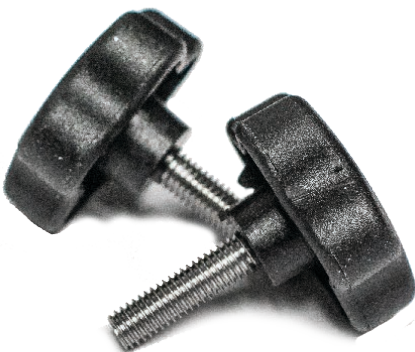

FIGURE C



TOOLS NEEDED

- Spade/Shovel
- Tape Measure
- Level
- Concrete Mix (C25)

OPTIONAL

- Clamshell (Fence Post Digger)
- Gravel
- #4Rebar (for structural support)



AURORA IN-GROUND INSTALLATION

SCAN THE QR-CODE TO INSTALLATION VIDEO

Your Aurora Cantilever comes with the Spigot already inserted in the mast of your umbrella. Once you have properly installed to your selected mount/base option, remove the Spigot from your umbrella and you can begin to mount your Spigot to the In-Ground Mount, and then the umbrella.

IMPORTANT: Where surface terrains differ, a different sized footing hole must be prepared and a different volume of concrete used. As a guide only; a hole 16” wide x 20” deep is recommended for heavy soil terrain. If installing the mount into topsoil or sand, you will need a larger hole and more concrete. We would recommend increasing the depth of the hole, however, it’s best that you seek appropriate advice from a licensed contractor for your specific circumstances.

1. Locate and identify your clearing to install your in-ground mount. (Be aware of the size and full rotation of the umbrella when considering placement.)
2. **(FIGURE 1)** Mark out a 16” diameter to begin digging (Center point of the Spigot **(30)**).
3. **(FIGURE 1)** Begin to dig a minimum depth of 20”

NOTE: These are minimum requirements. Wider and deeper depths can be implemented if the environment requires them.

4. **(FIGURE 1)** Begin to “Bell out” the bottem end of the hole to roughly 20” in diamter.

(FIGURE 1A) OPTIONAL: Fill the hole with 2-3” of gravel. Place a few #4 Rebar vertically in the gravel (Be sure to leave the center open for the in-ground mount insertion).

5. Begin to mix the concrete
6. Using a bucket or shovel, fill the installation hole to 1” below the surface (if you’ve used rebar and gravel, be sure to evenly displace the concrete).
7. **(FIGURE 2)** Unpack your in-ground mount and shimmy it down to the center of the poured concrete, leaving the surface plate just resting on the concrete surface.

NOTE: If you are butting you umbrella against a wall or corner, check that the mounting are parellel to visible 90° angles and straight lines.

8. **(FIGURE 2)** Check to make sure the mounting plate is level.
9. Even out the concrete under the plate so that there are no air pcokets or gaps.
10. Fill and cover the visible concrete wth surrounding soil.

IMPORTANT: Once the concrete has had 24-48 hours to cure (may vary depending on environment), remove the grub screws.

11. **(FIGURE 3)** Remove the spigot from your umbrella and attach to the in-ground mount surface place with the supplied hardware.

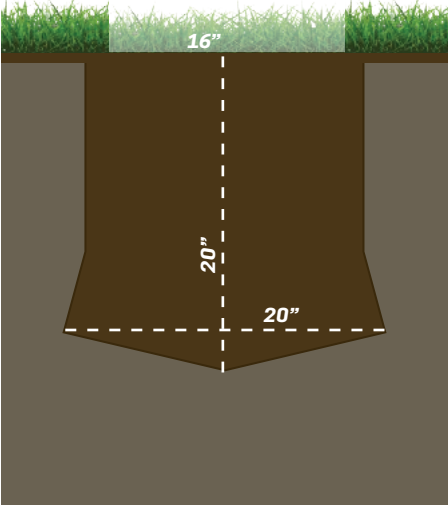

FIGURE 1

OPTIONAL

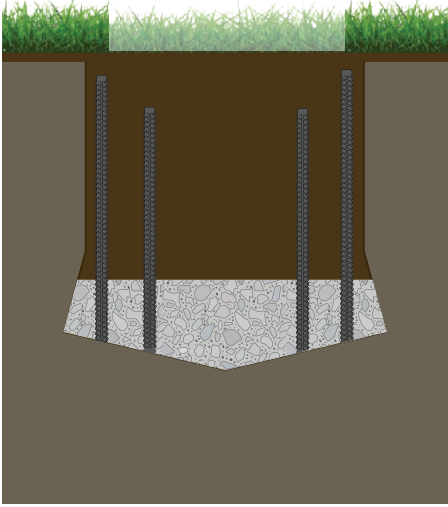

FIGURE 1A

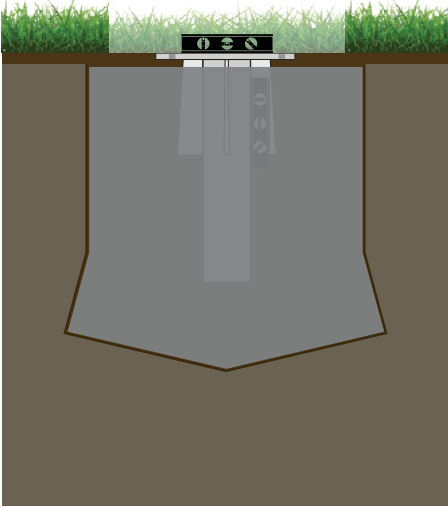

FIGURE 2

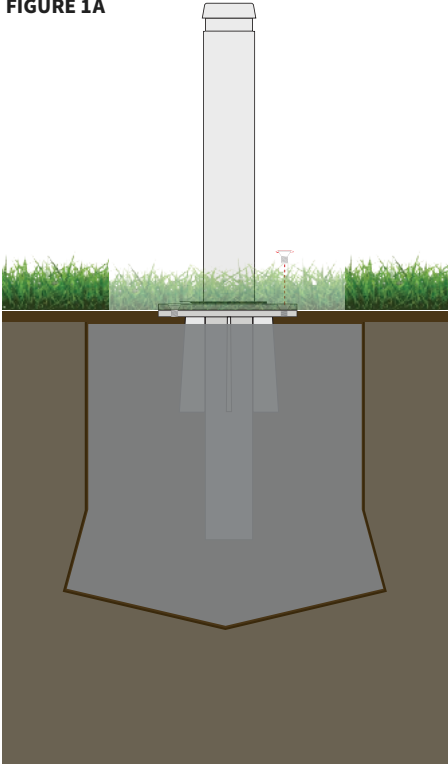
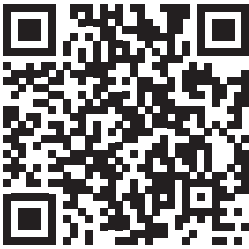

FIGURE 3



TOOLS NEEDED

- 11mm Drill Bit
- Wood Brace Block 2"+ thick
- #9 Coarse Wood Screws
- 1/2" x 4"+ Countersunk Wood Lag
- 1/2" x 3"+ Concrete Wedge Anchors
- (4) 1/2" Hex Nuts
- Tape Measure
- Level



AURORA DECK PLATE WOOD SURFACE INSTALLATION

SCAN THE QR-CODE TO INSTALLATION VIDEO

Your Aurora Cantilever comes with the Spigot already inserted in the mast of your umbrella. Once you have properly installed to your selected mount/base option, remove the Spigot from your umbrella and you can begin to mount your Spigot to the Deck Plate Mount, and then the umbrella.

1. **(FIGURE 1)** Choose the area of the deck for your installation. Place your deck plate down on the planks and mark the four outer holes. Be sure you're mounting between the joists (Be aware of the size and full rotation of the umbrella when considering placement).
2. **(FIGURE 2)** Remove your deck planks and measure distance between the joists.
3. **(FIGURE 3)** Securely fasten wooden brace blocks between the joists
4. **(FIGURE 4)** Replace the deck planks (leaving one open to access under the brace blocks) and place the deck plate over the areas you've marked for drilling.
5. **(FIGURE 4)** Using the 11mm drill bit, drill through the deck plate holes, through the brace block.
6. **(FIGURE 5)** Place Deck Plate on the drilled holes, attach hardware and secure from the underside of the joists.
7. Re-install the remaining deck planks.
8. **(FIGURE 6)** Remove the spigot from your umbrella and attach to the in-ground mount surface place with the supplied hardware.

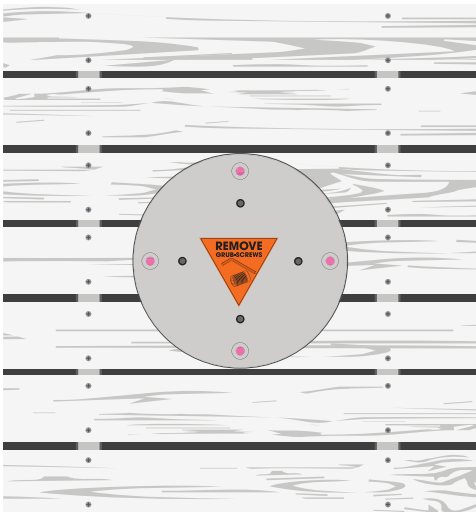

FIGURE 1

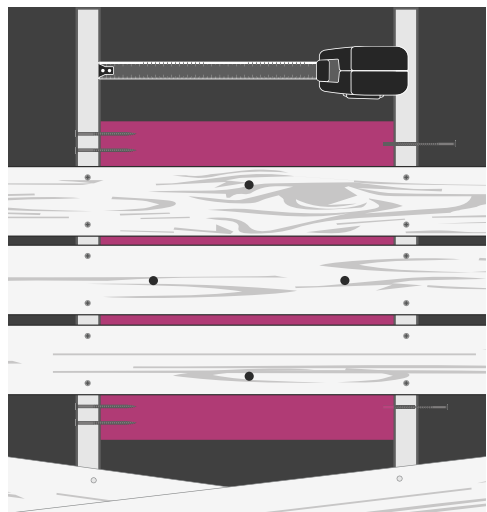

FIGURE 2

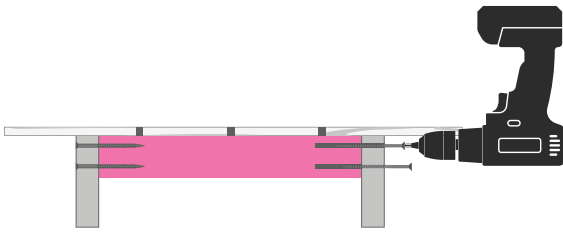

FIGURE 3

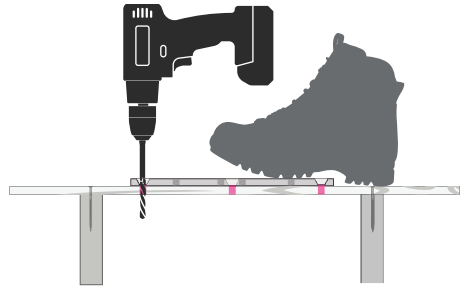

FIGURE 4

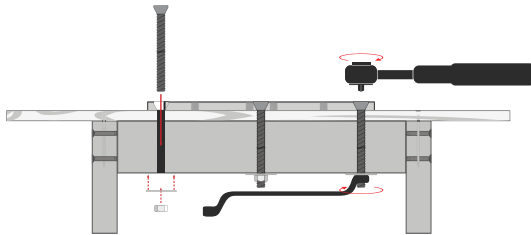

FIGURE 5

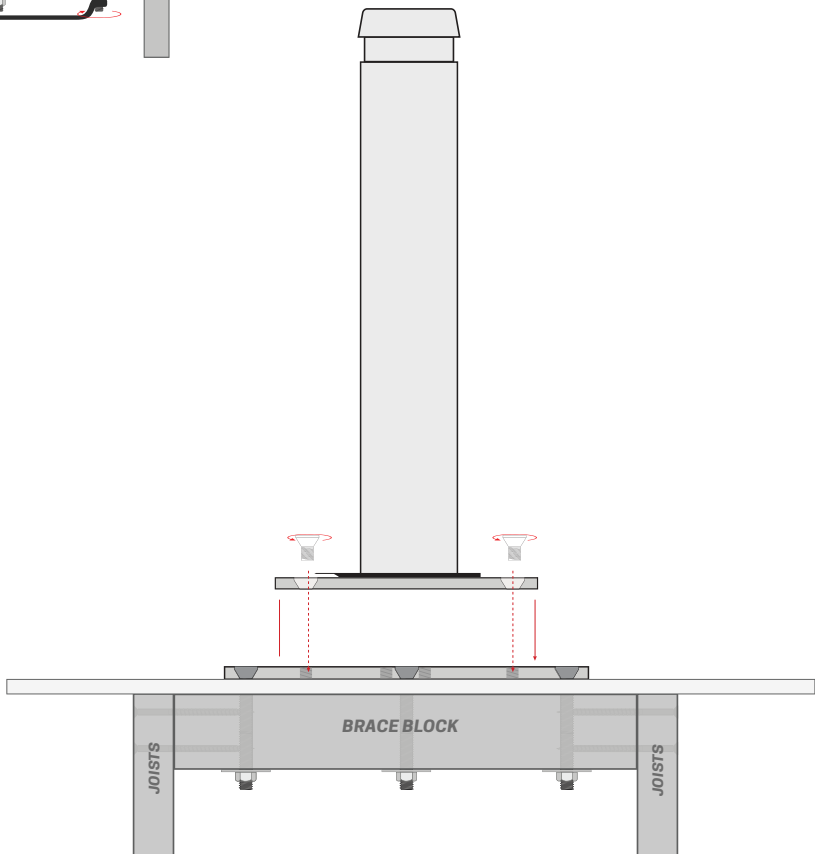
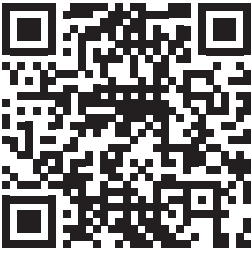

FIGURE 6



TOOLS NEEDED

- Hammer Drill
- 1/2" Masonry Bit (Med. Length)
- 3/8" Ratchet
- Tape Measure
- Level
- Chosen Concrete Fastners



AURORA DECK PLATE CONCRETE SURFACE INSTALLATION

SCAN THE QR-CODE TO INSTALLATION VIDEO

Your Aurora Cantilever comes with the Spigot already inserted in the mast of your umbrella. Once you have properly installed to your selected mount/base option, remove the Spigot from your umbrella and you can begin to mount your Spigot to the Deck Plate Mount, and then the umbrella.

1. **(FIGURE 1)** Choose the area of the concrete pad (minimum 4" of depth) for your installation. Place your deck plate down and mark the four outer holes (Be aware of the size and full rotation of the umbrella when considering placement).
2. Ensure your deck plate is square using the threaded holes as a guide and at least 12" from a back wall or fence.
3. Mark the holes with your drill bit.
4. **(FIGURE 2)** Using your masonry bit, drill 1" deeper than your selected hardware. Use masking tape to mark your target depth. (ex. 5" concrete pad, drill 4" down for 3" anchors).
5. **(FIGURE 3)** Place your deck plate over the holes.
6. Check to see if deck plate is level. If-not level, use stainless steel washers as shims to achieve a level surface.
7. **(FIGURE 3)** Install your chosen concrete anchors. Avoid using an impact drill.
8. **(FIGURE 4)** Remove the spigot from your umbrella and attach to the in-ground mount surface place with the supplied hardware.

FIGURE 1

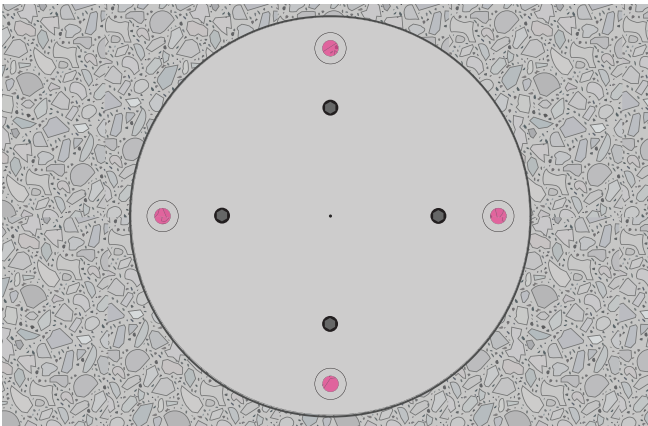

Put the Deckplate in place where you intend to mount your umbrella and mark where you need to drill into the concrete.

IMPORTANT: You will need at least 3 1/2" of solid depth for a sufficient installation. Any shallower than 3" the integrity of the install may be compromised causing catastrophic failure to your surface, the umbrella and surrounding property. Always consult a professional before installing.

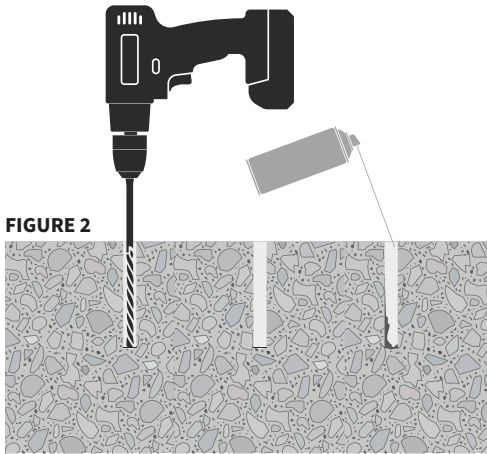
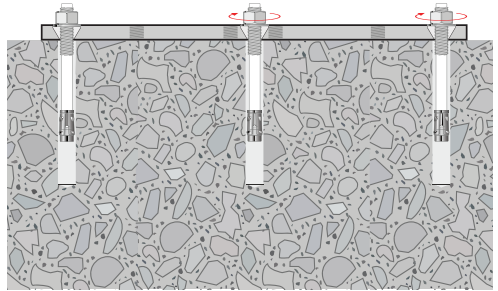

FIGURE 2

Be sure to blow dust out of holes before installing hardware.

FIGURE 3



Drop your hardware in (hammer in if-needed), and torque down all four bolts. (Flanged wedged anchors shown).

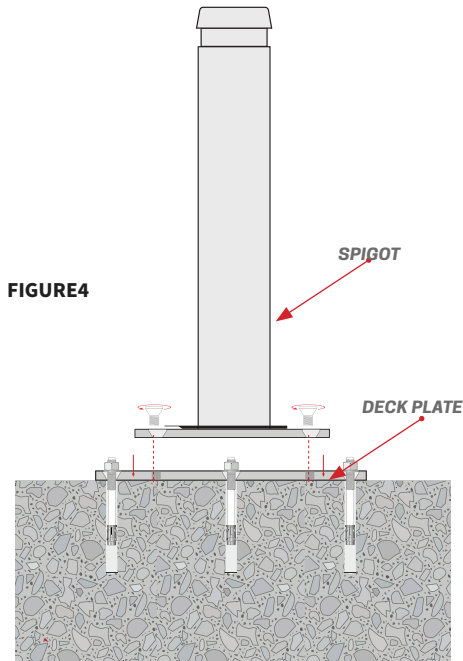
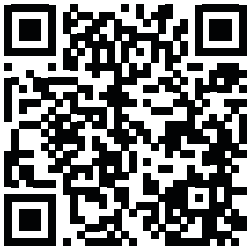

FIGURE 4

Mount your Spigot to the inner four threaded holes exposed by removing the grub-screws.



40G+36G GALVANIZED PLATE STACK

SCAN THE QR-CODE TO INSTALLATION VIDEO

Your Aurora Cantilever comes with the Spigot already inserted in the mast of your umbrella. Once you have properly installed to your selected mount/base option, remove the Spigot from your umbrella and you can begin to mount your Spigot to the Galvanized Plate Stack, and then the umbrella.

Once your Spigot is secure to the Galvanized Plate stack, begin to lift the Aurora onto the Spigot. Using the allen key that is attached your umbrella mast, lock it to the spigot using the bolt directly above the rotation handle.

1. Once your 40G plate is unpacked, move into the desired location you will be mounting the umbrella. Once in place immediately remove and discard ALL Grub-Screws from the G-Plate (**FIGURE 1**).
2. Locate your pair of Guide Pins and hand tighten into a pair of parallel threaded holes into the 40G-Plate you have set into place and is designated as your bottom plate (**FIGURE 1-A**).
3. Begin to unpack your second stacking plate. Using a half of the white packing foam, place on the edge of the bottom plate already in place and set down your plate (**FIGURE 2A**). This will help prevent any pinching of your fingers or injury.
4. **TWO PERSON JOB:** Lift your second stacking plate (**FIGURE 2**), and slowly stack the plate with the “naked” non-threaded holes over the Guide Pins. If the plate does not pass through and set down, please check to be sure you have rotated the plate to line up the “naked” holes with the Guide Pins.

NOTE: Repeat if using an additional 3rd or 4th plate.

5. Once all the plates are stacked, and over the Guide Pins, retrieve and remove the Spigot from the mast of your Aurora umbrella. Place the Spigot over the Guide Pins (**FIGURE 3**) then remove the Guide Pins and you will have a clear visible path to the bottom plate’s threaded holes.
6. With your Spigot in place on the galvanized plate stack lined up to the outer four bolts, use the supplied hardware that is packed with your umbrella and bolt the Spigot onto the plate stack threading down into the bottom plate (**FIGURE 3-A**). Once your Spigot is secure to the plate stack, begin to lift the Aurora onto the Spigot until you hear an audible “click” indicating your umbrella is secure.

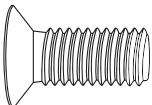

x4

6MM ALLEN WRENCH (REMOVE GRUB-SCREWS)

8MM ALLEN WRENCH (MOUNTING HARDWARE)

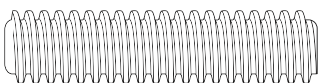

x2

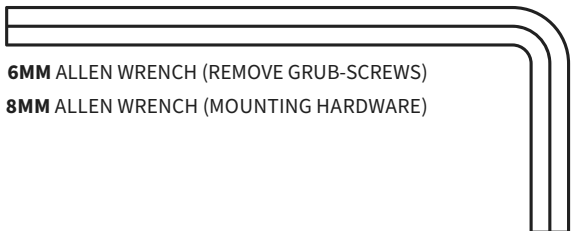

Same steps apply to the Triple and Quad Plate Stack

○ "NAKED" THREADLESS HOLES

● GRUB-SCREW (THREADED HOLES)

FIGURE 1

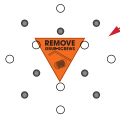
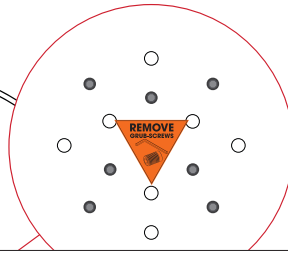

Remove all grub-screws from threaded holes on your Galvanized Plates.

PRO TIP: leave the grub-screws in your stacking plates to further help identify which holes to have the guide pins follow through. Remove the grub-screws from each plate before stacking another.

FIGURE 1-A

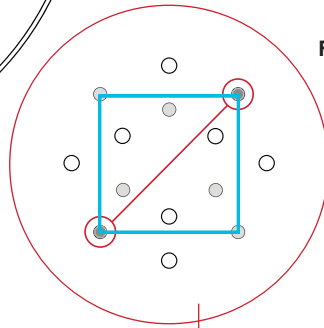

FIGURE 2

FIGURE 2-A

PACKING FOAM

36G-PLATE

40G-PLATE

Once your spigot is in place and on the Guide Pins, begin to remove them from the stack. This will give a clear visible path to the bottom plate's threaded holes.

After Guide Pins are removed, thread the supplied hardware to the bottom plate.

SPIGOT

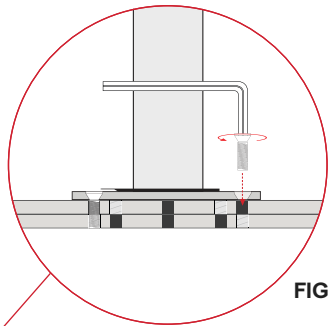

FIGURE 3-A

FIGURE 3 (Shown 40G+36G)



36G-PLATE

40G-PLATE

36G-SQx2 SQUARE GALVANIZED PLATE STACK



Your Aurora Cantilever comes with the Spigot (30) already inserted in the mast of your umbrella. Once you have properly installed to your selected mount/base option, remove the Spigot from your umbrella and you can begin to mount your Spigot to the Galvanized Plate Stack, and then the umbrella.

Once your Spigot is secure to the Galvanized Plate stack, begin to lift the Aurora onto the Spigot. Using the allen key that is attached your umbrella mast, lock it to the spigot using the bolt directly above the rotation handle.

1. Once your 36G-SQ (Bottom Plate) is unpacked, move into the desired location you will be mounting the umbrella. Once in place immediately remove and discard ALL Grub-Screws from the Galvanized Plate (**FIGURE 1**).

NOTE: If you are installing Caster Wheels (+**HDW-KIT**), do-so before stacking your “Top Plates” (If you choose to use wheels after you’ve created a stack, you will have to remove the top plate to install the wheels). Once your wheels are installed, be sure to lock them in place while completing your stack.

2. Locate your pair of Guide Pins and hand tighten into a pair of parallel threaded holes into the 36G-SQ (Bottom Plate) you have set into place (**FIGURE 1-A**).
3. Begin to unpack your 36G-SQ (Top Plates). Using a half of the white packing foam, place on the edge of the bottom plate already in place and set down your plate (**FIGURE 2A**). This will help prevent any pinching of your fingers or injury.
4. **TWO PERSON JOB:** Lift your second 36G-SQ (Top Plates) (**FIGURE 2**), and slowly stack the plate over the Guide Pins. Repeat for your remaining plates to complete the stack.
5. Once the plates are stacked, and over the Guide Pins, retrieve and remove the Spigot from the mast of your Aurora umbrella. Place the Spigot over the Guide Pins (**FIGURE 3**) then remove the Guide Pins and you will have a clear visible path to the bottom plate’s threaded holes.
6. With your Spigot in place on Galvanized Plate stack lined up to the outer four bolts, use the supplied hardware that is packed with your umbrella and bolt the Spigot onto the Galvanized Plate stack threading down into the bottom plate (**FIGURE 4**).

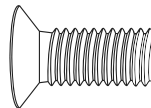
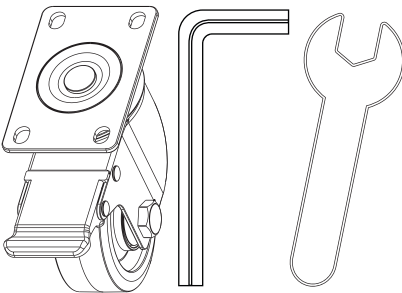

x4

HDW-KIT

x4 Caster Locking Wheels
x16 Caster Fasteners + Hardware

5mm Allen Key (Caster Wheel Specific)
13mm Box Wrench (Caster Nut)



FIGURE 1- BOTTOM PLATE / “THREADED PLATE”

Same steps apply to the Triple and Quad Plate Stack

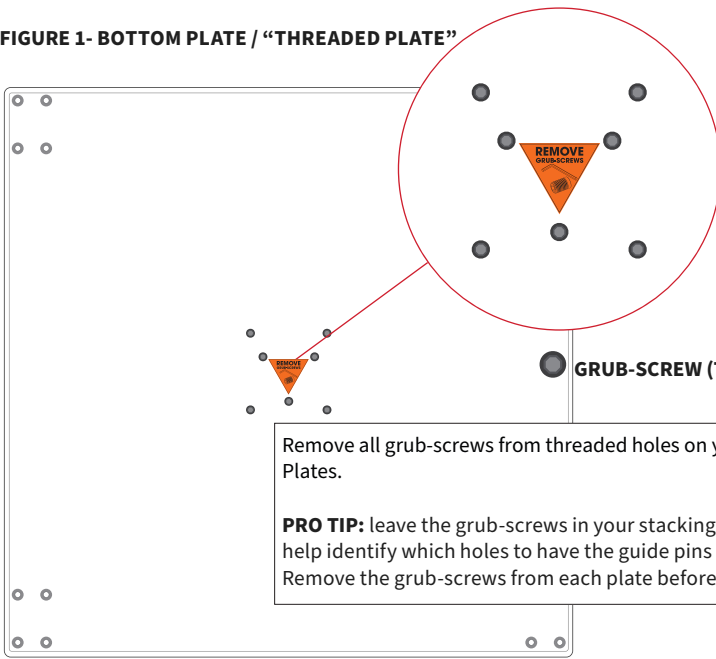

GRUB-SCREW (THREADED HOLES)

Remove all grub-screws from threaded holes on your Galvanized Plates.

PRO TIP: leave the grub-screws in your stacking plates to further help identify which holes to have the guide pins follow through. Remove the grub-screws from each plate before stacking another.

FIGURE 1-A

FIGURE 2- STACKING PLATE / “TOP PLATE”

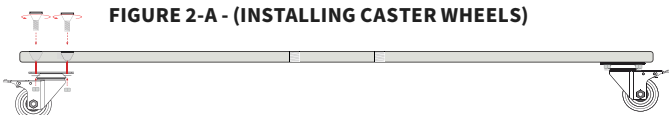
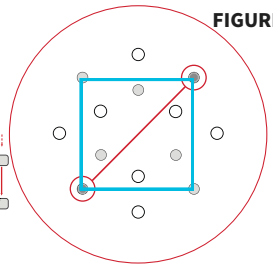
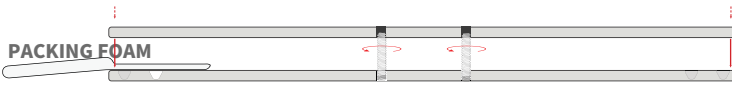

FIGURE 2-A - (INSTALLING CASTER WHEELS)

If installing Caster Wheels, you must install to your bottom 36G plate before stacking other plates. Be sure to lock your wheels before stacking other plates.

FIGURE 4

After Guide Pins are removed, thread the supplied hardware to the bottom plate.

FIGURE 3

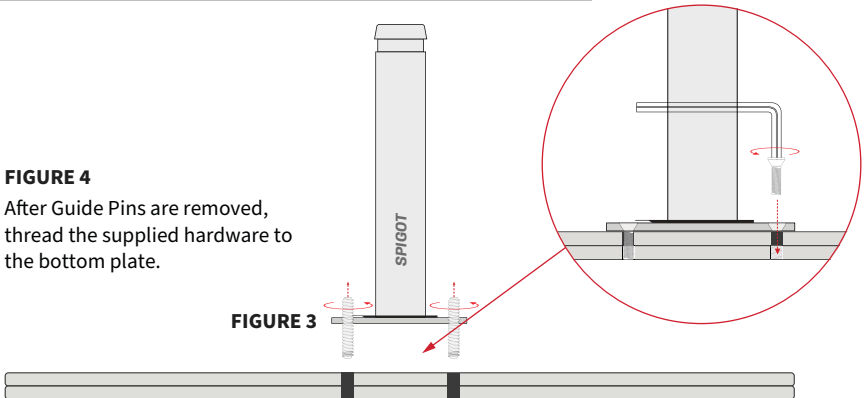

AURORA 480 ROLLING BASE



Your Aurora comes with the Spigot (30) already inserted in the mast of your umbrella. Once you have properly leveled your base (If adjustable feet used) or have installed the caster wheels and have them in the locked position, you can begin to mount your Spigot (30) and then umbrella. (FIGURE 1).

IMPORTANT: Your umbrella mounting hardware, wheels (hardware) and adjustable feet are packed within the base. Remove the lid to locate and retrieve your hardware and accessories. Proceed to remove the grub-screws from the mounting plate on the ARU-480.

1. Once you have unpacked your ARU-480, remove the lid, locate and retrieve your mounting hardware, wheels (hardware) and adjustable feet. Choose which you would like to use and install before weighing down with pavers and/or weights.
2. After you have installed the wheels or feet, pavers should be placed in the base corner towards the center first (FIGURE 1), under the mounting plate. Repeat in each quadrant until the base is full with Twelve (12) appropriately weighted pavers.
3. After your base is sufficiently weighed down, place the lid back onto the base (FIGURE 2), lock your wheels if installed, and retrieve your Spigot (30) from the mast of the Aurora.
4. Mount your Spigot (30) to the 480 with the included mounting hardware on the outer threaded pattern (FIGURE 3A).
5. With your Spigot in place and on 480 Mounting Plate, use the supplied hardware that is packed with your umbrella and bolt the Spigot onto the plate threading down to only the plate (FIGURE 3). Once your Spigot is threaded down, begin to lift the Aurora onto the Spigot until you hear an audible “click” indicating your umbrella is secure.

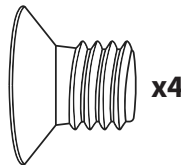
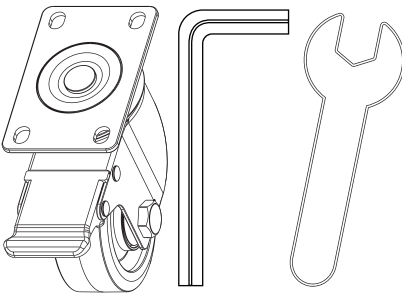

HDW-KIT

x4 Caster Locking Wheels
x16 Caster Fasteners + Hardware

5mm Allen Key (Caster Wheel Specific)
13mm Box Wrench (Caster Nut)



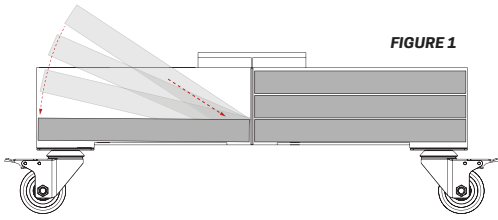

FIGURE 1

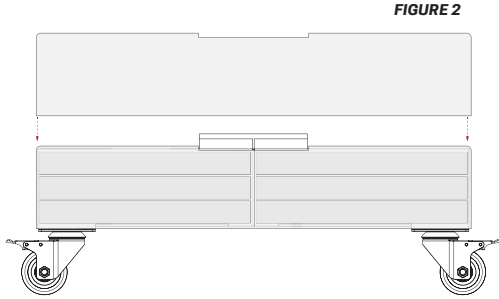
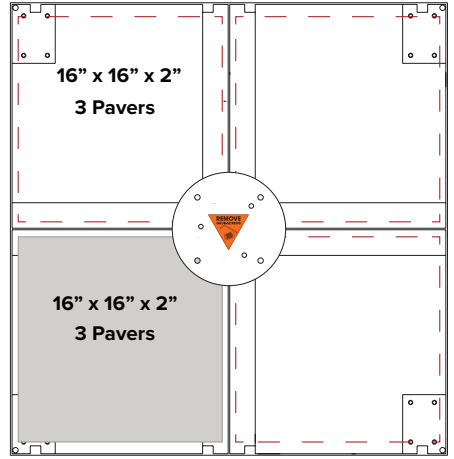

FIGURE 2

FIGURE 3

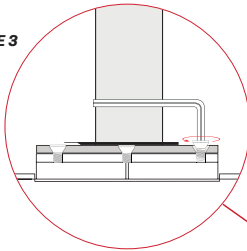
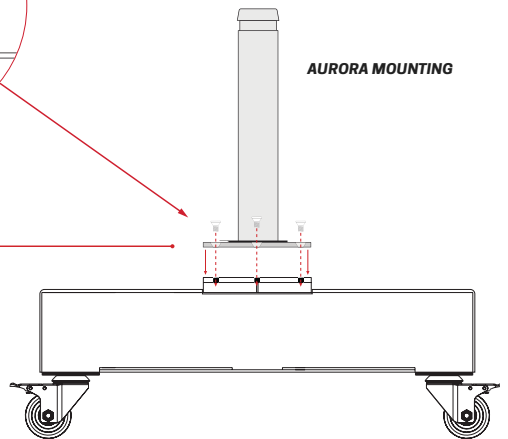
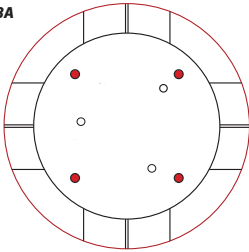

FIGURE 3A





110 Gaither Drive
Mount Laurel, NJ 08054
info@frankfordumbrellas.com
frankfordumbrellas.com